

# INVELOPE HORIZONTAL BACK-UP

FORMED METAL WINDOW HEAD FLASHING

SHOP APPLIED AIR/VAPOR BARRIER SEALANT

CONTINUOUS SUBGIRT FOR VERTICAL RAIL SUPPORT

VERTICAL TILE SUPPORT RAIL

CONTINUOUS ZEE FOR VERTICAL RAIL SUPPORT

SUPPORT DEAD LOAD CLIP, AS REQUIRED

TILE SUPPORT CLIP

HORIZONTAL INVELOPE PANEL

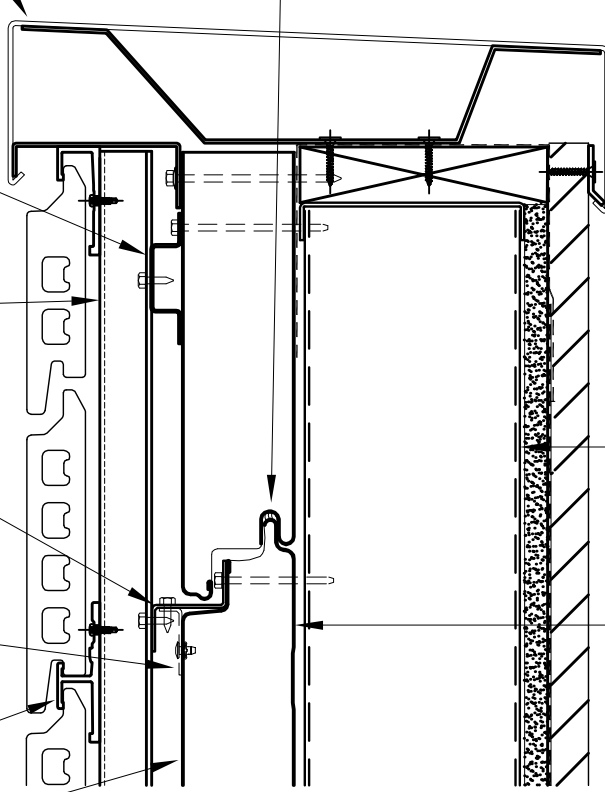

STEEL STUD 16 GA. MIN.

BACK OF INVELOPE ESTABLISHES AIR/VAPOR BARRIER

LONGOTON M2 Terra Cotta Tile over INVELOPE Insulated Metal Panel

Horizontal Panel @ Coping Vertical Rail

# INVELOPE HORIZONTAL BACK-UP

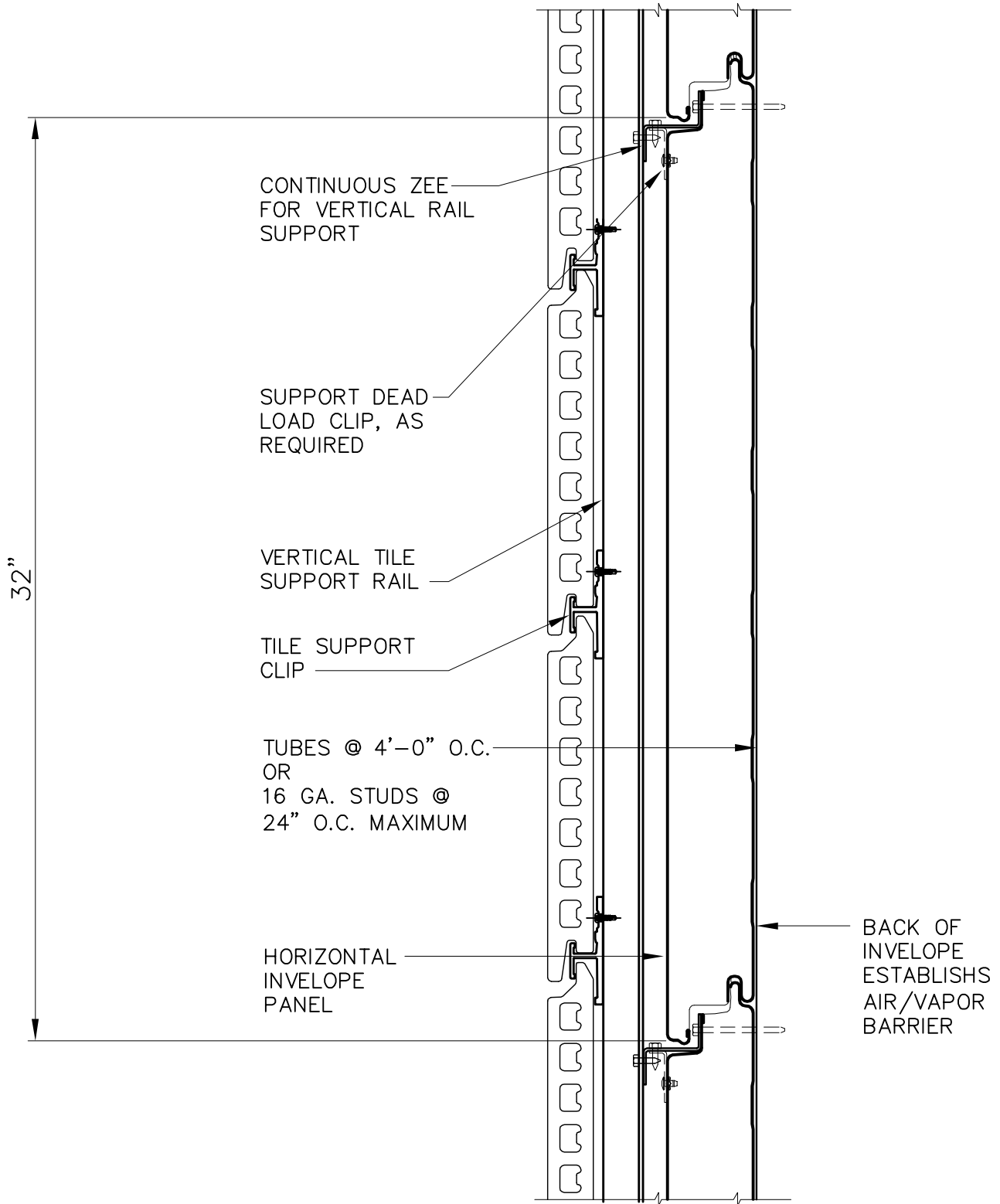

LONGOTON M2 Terra Cotta Tile over  
INVELOPE Insulated Metal Panel

Horizontal Panel Joint With  
Vertical Rail

June 09

# INVELOPE HORIZONTAL BACK-UP

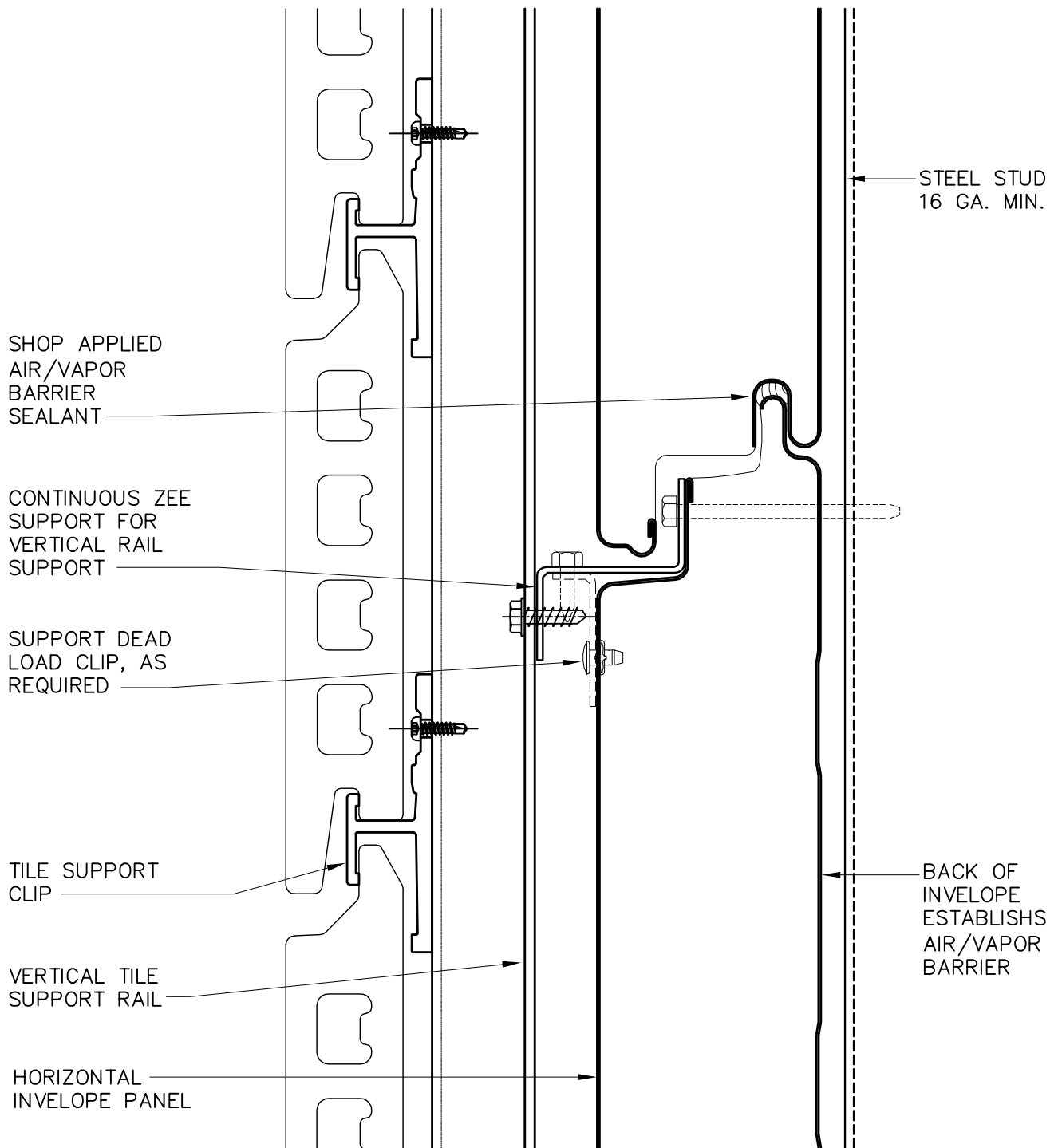

LONGOTON M2 Terra Cotta Tile over  
INVELOPE Insulated Metal Panel

Horizontal Panel Joint w/ Zee Support  
Vertical Rail

# INVELOPE HORIZONTAL BACK-UP

TUBES @ 4'-0" O.C. OR  
16 GA. STUDS @  
24" O.C. MAXIMUM

SHOP APPLIED AIR/VAPOR  
BARRIER SEALANT

CONTINUOUS ZEE FOR  
VERTICAL RAIL  
SUPPORT

SUPPORT DEAD LOAD CLIP,  
AS REQUIRED

INVELOPE INSULATED  
BACK-UP PANEL

BACK OF INVELOPE  
ESTABLISHES AIR/VAPOR  
BARRIER

FIRE SAFING AT  
FLOOR SLAB  
BY OTHERS

VERTICAL SUPPORT  
RAIL

TILE SUPPORT CLIP

INTERIOR  
GYPSUM  
BOARD

STEEL STUD  
16 GA. MIN.

CONCRETE  
FLOOR  
SLAB

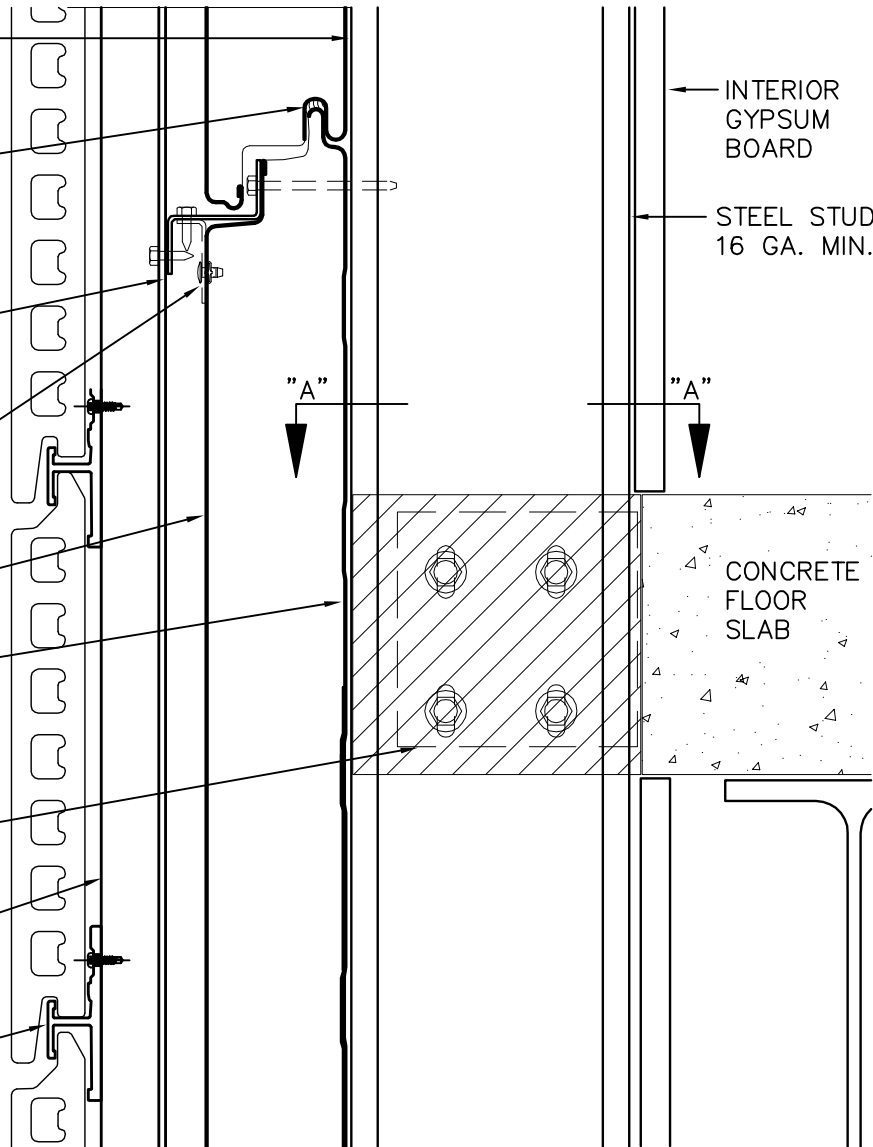

3"

ANCHOR

STUD SUPPORT CLIP  
WITH VERTICAL SLOTS.  
CENTER FASTENERS IN  
THE SLOT, USE METAL  
WASHERS AT SLOTS.

STEEL STUD  
16 GA. MIN.

SECTION A-A

LONGOTON M2 Terra Cotta Tile over  
INVELOPE Insulated Metal Panel

Supports Extending Past Floor Slab  
Vertical Rail

# INVELOPE HORIZONTAL BACK-UP

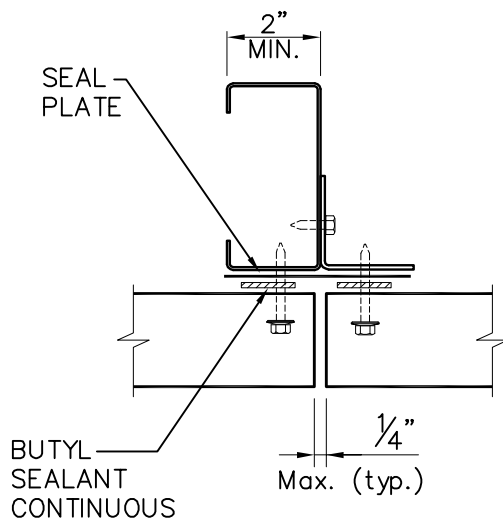
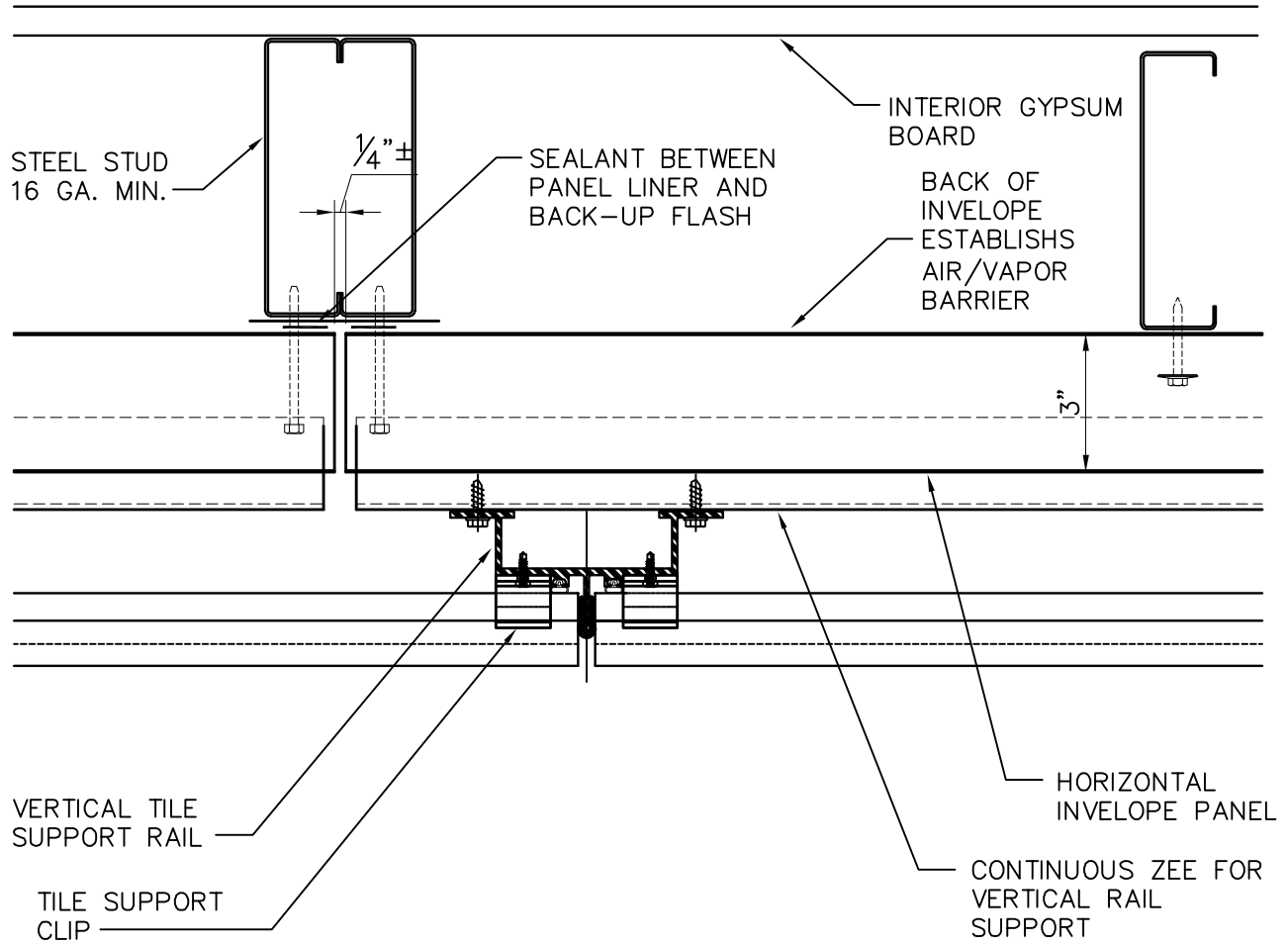

LONGOTON M2 Terra Cotta Tile over  
INVELOPE Insulated Metal Panel

Vertical Joint @ Horizontal Panel  
Vertical Rail

# INVELOPE HORIZONTAL BACK-UP

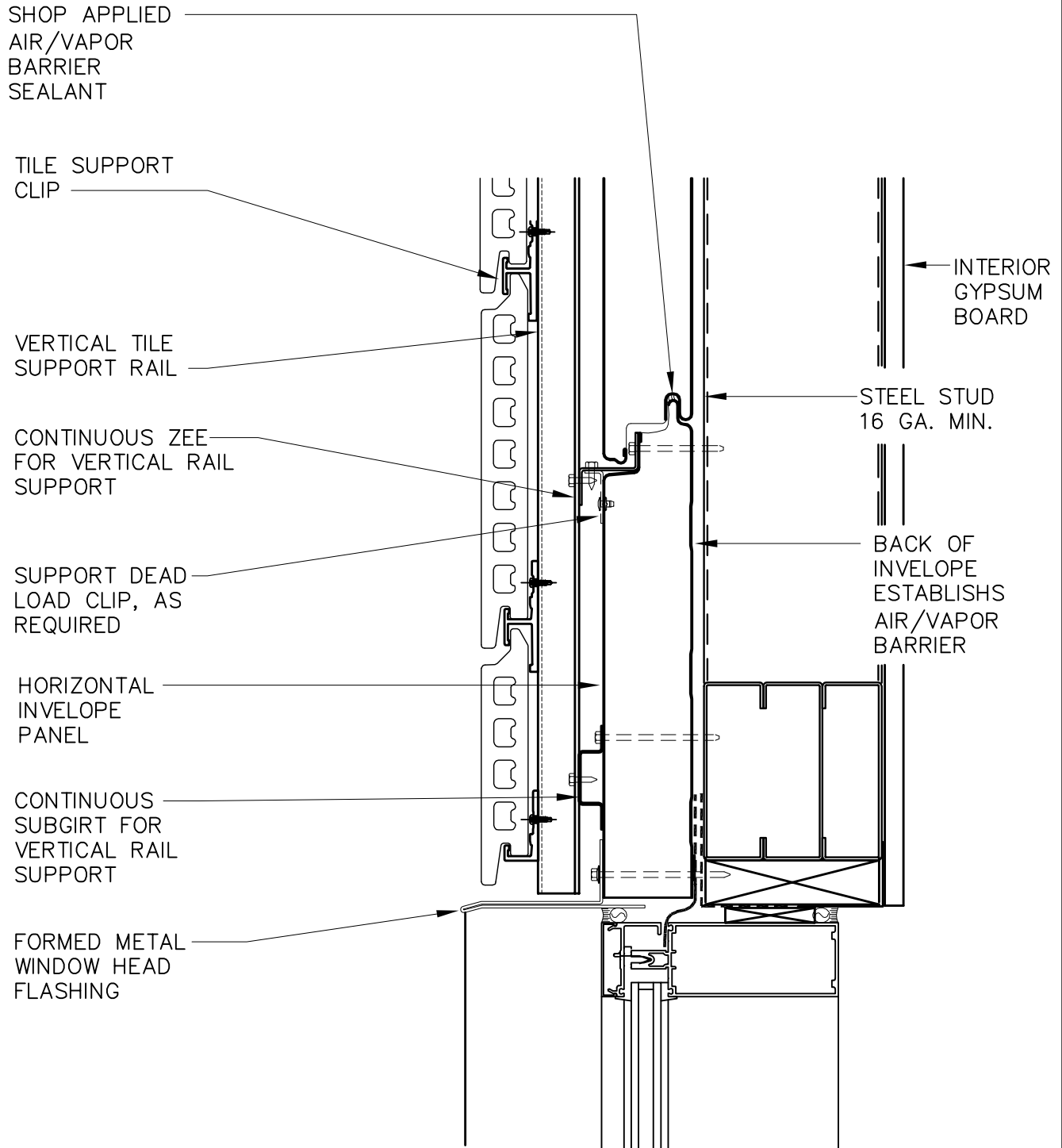

LONGOTON M2 Terra Cotta Tile over INVELOPE Insulated Metal Panel

Horizontal Panel @ Window Head  
Vertical Rail

# INVELOPE HORIZONTAL BACK-UP

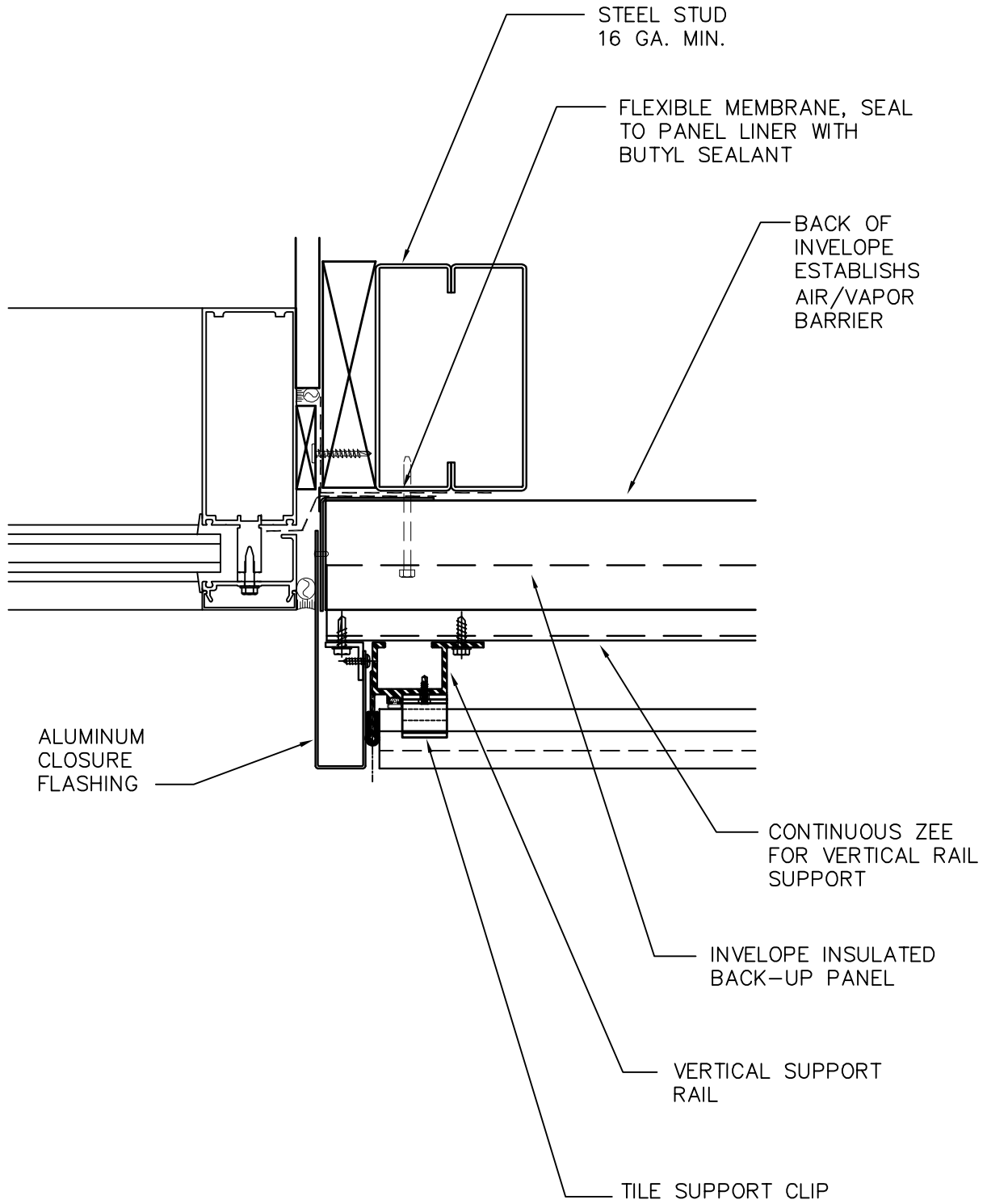

LONGOTON M2 Terra Cotta Tile over  
INVELOPE Insulated Metal Panel

Window Jamb Horizontal Envelope Panel  
Vertical Rail

# INVELOPE HORIZONTAL BACK-UP

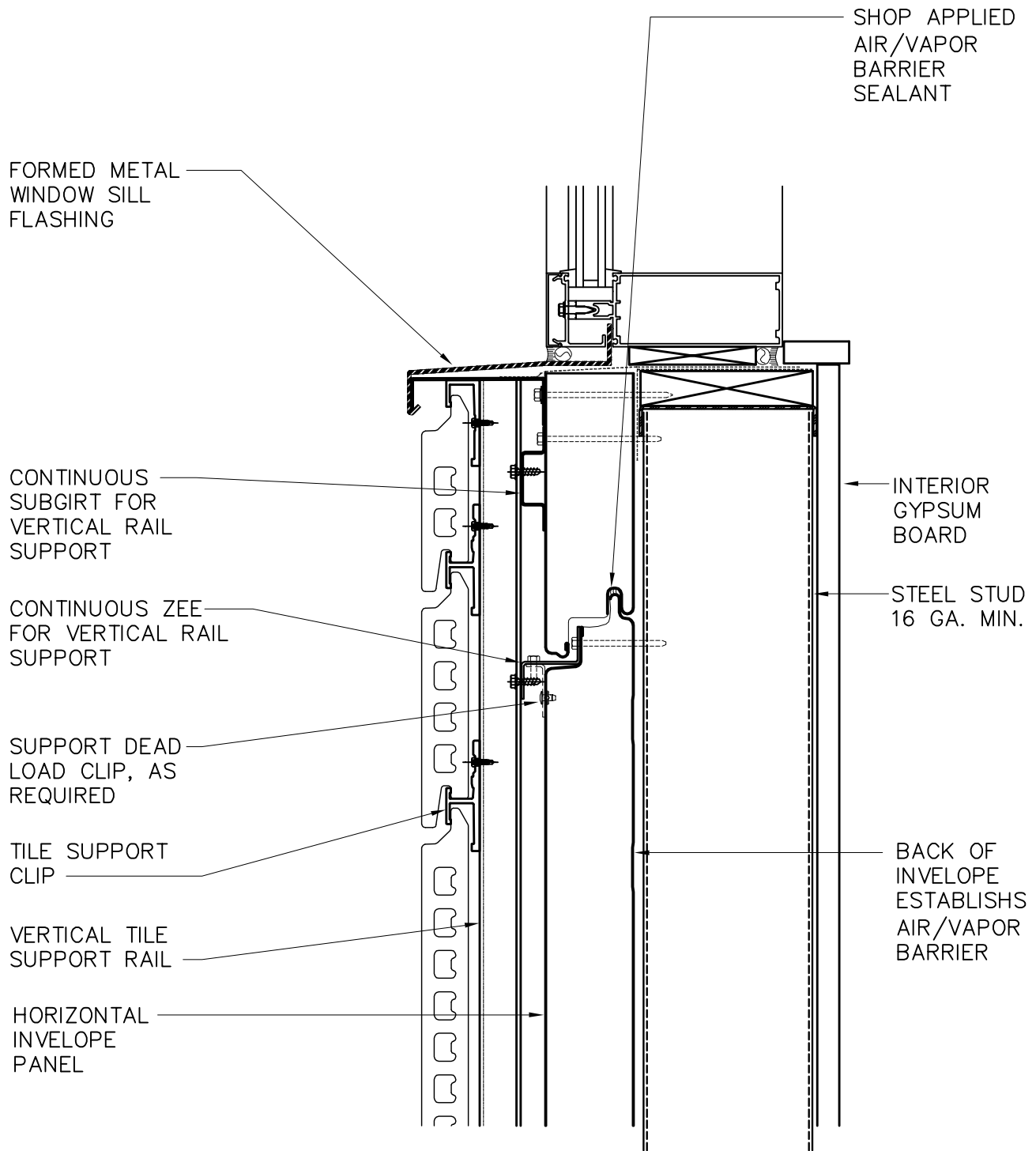

LONGOTON M2 Terra Cotta Tile over  
INVELOPE Insulated Metal Panel

Horizontal Panel @ Window Sill  
Vertical Rail

June 09